

ENTRE™ SYSTEM
PNEUMATIC COMPRESSION DEVICE

User Guide

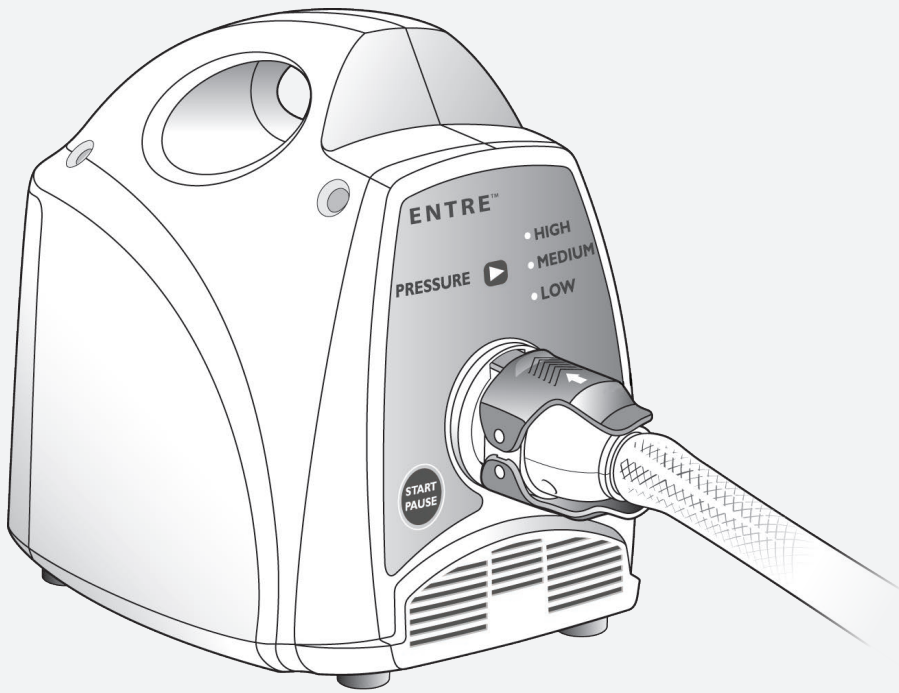

Table of Contents

Chapter 1 Before You Get Started	1
1.1 How to Contact Tactile Medical.....	1
1.2 Safety Precautions and Explanation of Symbols.....	2
1.3 Indications for Use.....	4
1.4 Contraindications.....	5
1.5 Unpacking Instructions	5
1.6 Labels.....	6
Chapter 2 The Entre System	7
2.1 System Components.....	7
2.2 Adjustable Pressure Levels	8
2.3 Treating the Lower Extremity.....	9
2.4 Treating the Upper Extremity	10
Chapter 3 Controller Unit Set-Up	11
3.1 Setting Up the Controller Unit.....	11
3.2 Connecting the Hose to the Controller Unit.....	12
Chapter 4 Garment Application	15
4.1 Applying the Full Leg and Half Leg Garment.....	16
4.2 Applying the Arm Garment	17
Chapter 5 Conducting a Therapy Session	19
5.1 Selecting Your Pressure Setting	19
5.2 Starting the Therapy Session	20
5.3 Pausing the Therapy Session.....	21
5.4 Completing the Therapy Session	21
5.5 Storing the Entre System.....	21
5.6 Cleaning the Entre System	22
5.7 Disinfecting the Entre System	23

Chapter 6 Troubleshooting and Specifications 24

Chapter 7 Warranty 28

- 7.1 Limited Warranty and Service for Home Use28
- 7.2 Limited Warranty and Service for Facility Use29
- 7.3 Return Policy29
- 7.4 Equipment Lifetime.....29

Chapter 8 Technical Information 30

- 8.1 Technical Information.....30
- 8.2 Device Labels.....34

For Additional Questions..... Back Cover

Before You Get Started

Read the entire guide before attempting to connect or operate this product. Keep this guide for future reference.

The Entre system is a pneumatic compression device designed for at-home treatment of lymphedema, chronic edema, venous insufficiency and chronic wounds. When used daily, pneumatic compression can help you manage your condition, improve your health, and allow you to enjoy a better quality of life.

This guide provides the information needed to set up and use your Entre system.









1.1 How to Contact Tactile Medical

If you have questions about the Entre system or require service, contact Tactile Medical:

- Customer Service: 612.355.5100 or 833.382.2845 (833.3TACTILE) (toll free, U.S. only) 7 a.m. to 7 p.m. Central Time, Monday–Friday.
- You may also email us at info@tactilemedical.com.

If you have medical questions, please contact your physician or healthcare provider.

1.2 Safety Precautions and Explanation of Symbols

	<p>IMPORTANT: Read Instructions Before Using Before attempting to connect or operate this product, please read the entire guide. Keep this guide available for future reference.</p>
	<p>CAUTION</p>
	<p>Manufacturer's Part Number</p>
	<p>Rx Only CAUTION: U.S. Federal law restricts this device to sale by, or on the order of, a licensed healthcare professional.</p> <p>Consult your physician or other healthcare provider for recommendations regarding your therapy program, treatment cycles, and/or duration of treatment. Use this product only at the settings prescribed by your healthcare provider.</p>
	<p>Do NOT Dispose With General Household Waste Tactile Medical complies with the Waste Electric and Electronic Equipment Directive (WEEE) 2002/96/EC. Contact Tactile Medical at 612.355.5100 or 833.382.2845 (833.3TACTILE) (toll free, U.S. only) to get disposal instructions.</p>
	<p>Type BF Applied Part</p>
	<p>Device Serial Number</p>
	<p>Intertek Mark Product Category: Medical Equipment Product Category CCN: PIDF Class II with respect to electrical shock, fire and mechanical hazards only in accordance with EN60601-1</p>
<p>IP21</p>	<p>The Entre system complies with IEC60329 regarding the degree of protection against water and particulates.</p>

EMC Precautions

The Entre system is Medical Electrical Equipment that has been tested and demonstrated to be compatible with electromagnetic compatibility (EMC) CISPR 11 Class B limits and is therefore suitable for use in hospital, clinic and home care environments.

WARNING: Although the Entre system has no essential performance affected by EMC, use of this equipment adjacent to or stacked with other equipment should be avoided because it could result in improper operation. If such use is necessary, this equipment and the other equipment should be observed to verify that they are operating normally.

WARNING: Power cords can be affected by EMC. Use only the power cord provided by Tactile Medical.

WARNING: Portable RF communications equipment (including peripherals such as antenna cables and external antennas) should be used no closer than 30 cm (12 inches) to any part of the Entre system.

WARNING: Risk of Electric Shock

- Do not attempt to service the controller unit. Such attempts could result in injury or damage to the product, and will void any warranty.
- Do not disassemble the controller unit.
- Unplug the controller unit when not in use.
- The Entre system is to be used indoors only.
- Do not use the controller unit near water or while bathing.
- Do not reach for the controller unit if it falls into water. Unplug the controller unit at the electrical outlet immediately.

WARNING: Risk of Personal Injury

- Use the controller unit only for its intended purpose, as directed in this guide.
- Use only the power adapter provided with your Entre system.
- Use only accessories approved by Tactile Medical. Other accessories may damage the system or interfere with system function.
- Setup the controller unit in a manner that provides easy access to the power adapter should it become necessary to unplug quickly.
- Never operate the controller unit if the power adapter or plug is not working properly, if it has been damaged, or if the controller unit has been dropped into water. Return it to Tactile Medical for inspection and/or replacement. Do not modify the power adapter or plug.

WARNING: Risk of Personal Injury, continued

- Keep the power adapter away from heated surfaces.
- Never operate the controller unit where the power adapter or tubing harness will present strangulation or tripping hazard.
- Strangulation potential: Power adapter and tubing bundle should never be placed near or around a person's neck.
- Do not use the Entre system in the presence of flammable gasses, including flammable anesthetics.

CAUTION: Risk of Device Damage

- Never block the ventilation openings on the back or the sides of the controller unit. Keep the ventilation openings free of debris such as lint and hair.
- Never operate the controller unit on a soft surface, such as a bed, couch, or pillow, where the ventilation openings may be blocked.
- Never drop or insert any object into any opening of the controller unit.
- Never use sharp objects, such as pins, scissors or clasps on or near the Entre system.
- Never use hot devices such as irons or blow dryers, on or near the Entre system.

1.3 Indications For Use

The Entre system is intended for use by medical professionals and patients who are under medical supervision, for the treatment of the following conditions:

- Chronic edema
- Lymphedema
- Venous insufficiency
- Wound healing

1.4 Contraindications

The Entre system should not be used if you have one or more of the following conditions:

- Heart failure (acute pulmonary edema, decompensated acute heart failure)
- Acute venous disease (acute thrombophlebitis, acute deep venous thrombosis, acute pulmonary embolism)
- Severe peripheral artery disease (critical limb ischemia including ischemic rest pain, arterial wounds or gangrene)
- Active skin or limb infection/inflammatory disease (acute cellulitis, other uncontrolled skin or untreated inflammatory skin disease)
- Active cancer (cancer that is currently under treatment, but not yet in remission)
- Any circumstance where increased lymphatic or venous return is undesirable

1.5 Unpacking Instructions

When your Entre system arrives, it is important that you carefully unpack the contents and ensure that you have all the equipment required to begin operation. Allow the controller unit to reach room temperature for one hour before using.

Included in the box, you should find the following:

- User Guide
- Controller unit
- Garment(s) and accessory(ies) to treat your condition
- Power adapter

The garment(s) and accessory(ies) you receive will depend upon your individual therapy requirements. If you are missing any of the items listed for your prescribed treatment, please contact Customer Service at 612.355.5100 or 833.382.2845 (833.3TACTILE) (toll free, U.S. only).

Lower Extremity Treatment

The garments and device accessory(ies) needed for lower extremity treatment may include the following:

- Full leg garment
- Half leg garment
- “Y” connector (provided only if bilateral therapy is ordered)
- Extender (provided only if ordered)

Upper Extremity Treatment

The garments and device accessory needed for upper extremity treatment may include the following:

- Arm garment
- “Y” connector (provided only if bilateral therapy is ordered)

1.6 Labels

The label is located where the tubing attaches to the garment or accessory. It indicates the body area the garment or accessory is to be applied (full leg, half leg and arm) (Figure 1.6.a).

Figure 1.6.a: Label Examples



The Entre System

The Entre system is a pneumatic compression device that delivers intermittent sequential compression therapy to the affected extremities of patients with lymphedema, chronic edema, venous insufficiency, and chronic wounds.

NOTE: *No special skills, training or knowledge is required to operate the Entre system.*

2.1 System Components

The Entre system consists of two primary components:

Controller Unit

The controller unit delivers compressed air via a hose connector which is attached to the garment. Depending on the prescription from your physician, a “Y” connector can be added to allow two garments to be used at the same time. The device applies different levels of pressure along the length of your limb. For example, your toes or fingers will receive more pressure; your thigh or upper arm will receive less.

Garments and “Y” Connector

The air-chambered garments are made of soft, pliable nylon and polyester fabrics. They are designed to fit around the limb(s) and fasten with zippers.

The upper extremity garment(s) are used to treat the arm.

Depending on your clinical needs and size, you may be prescribed a short or long arm garment.

The lower extremity garment(s) are used to treat the leg. Depending on your clinical needs and size, you may be prescribed a short or long full leg garment (with corresponding extender), or a half leg garment.

The “Y” connector. If your healthcare provider ordered bilateral treatment you will receive a “Y” connector accessory.

2.2 Adjustable Pressure Levels

Your healthcare provider will determine what pressure setting(s) are appropriate for you. The Entre controller unit allows for selection of pressure settings (see Figure 2.2.a). To select the pressure setting recommended by your healthcare provider press the pressure button to toggle to the correct pressure setting.

NOTE: *Please consult with your healthcare provider before changing pressure settings.*

Figure 2.2.a: Front Panel

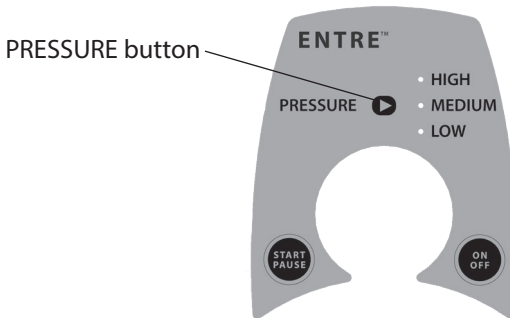

2.3 Treating the Lower Extremity

Full Leg Treatment

This option provides full leg treatment in a distal to proximal (foot to top of thigh) direction via the sequential inflation of the 8 chambers.

Treatment time: 60 minutes

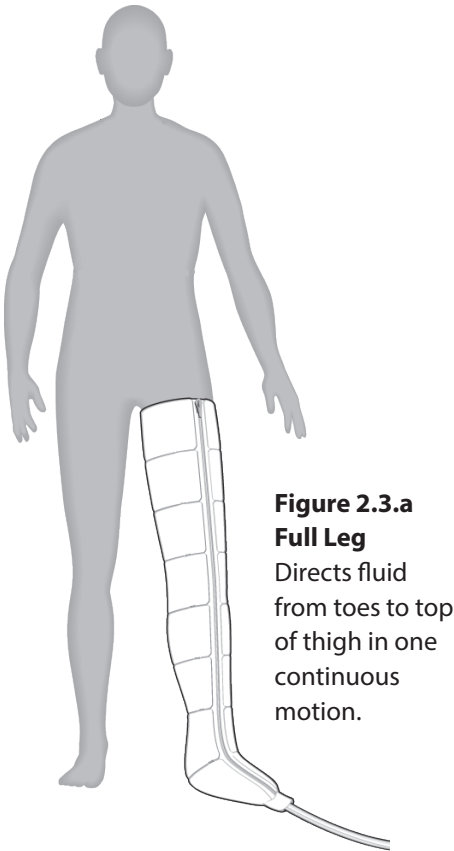

Half Leg Treatment

This option provides below the knee treatment in a distal to proximal (foot to top of knee) direction via the sequential inflation of the 8 chambers.

Treatment time: 60 minutes

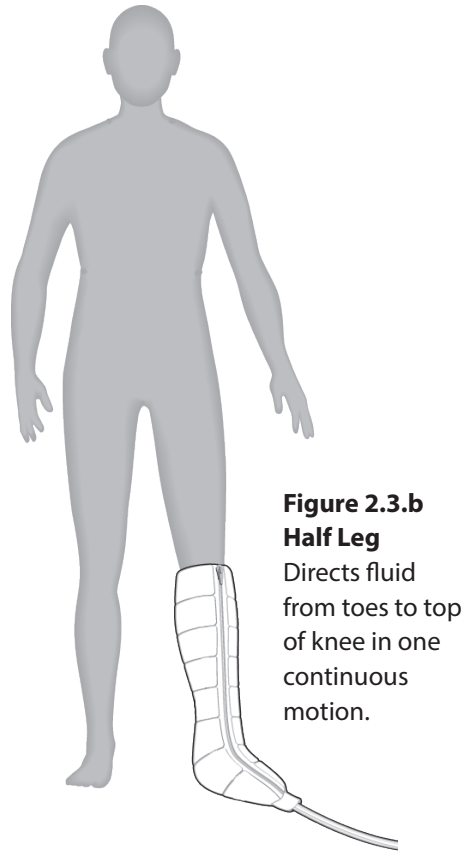

2.4 Treating the Upper Extremity

Full Arm Treatment

This option provides full arm treatment in a distal to proximal (hand to top of biceps) direction via the sequential inflation of the 8 chambers.

Treatment time: 60 minutes

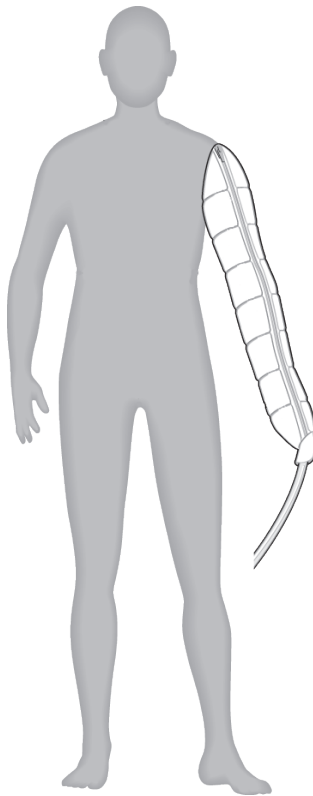

Figure 2.4.a
Arm

Begins at fingertips and ends at top of biceps in one continuous motion.

Controller Unit Set-Up

In this chapter you will learn how to set up the controller unit and select the proper settings prior to receiving therapy.

3.1 Setting Up the Controller Unit

Follow the steps outlined below:

1. Find an appropriate location for a therapy session (e.g., couch, bed). Place the controller unit on a sturdy, flat surface near an electrical outlet. Position the device so you have easy access to the plug.
2. Plug the supplied power adapter into the power adapter inlet on the back of the controller unit. Then, plug the two-pronged power adapter into an electrical outlet (Figure 3.1.a).

NOTE: There are two 12 VDC power adapter options, so the version shown below may be different from the one you receive. The two versions are:

- Meanwell GSM36U12-P1JNX
- Fuhua UE36LCP1-120300SPA

Figure 3.1.a: Power Adapter

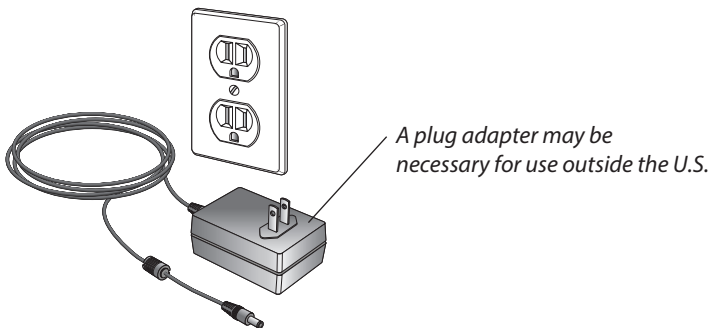

WARNING: RISK OF ELECTRIC SHOCK

Only use the Meanwell GSM36U12-P1JNX or Fuhua UE36LCP1-120300SPA power adapter with your Entre system. These power adapters are designed for use with either 120 Volt AC or 230 Volt AC outlets.

3.2 Connecting the Hose to the Controller Unit

The controller unit should be connected to the garments before the garments are applied. If you are receiving bilateral treatment you will have received a “Y” connector with your shipment. The “Y” connector must be connected to the controller unit prior to connecting your garments.

NOTE: Both garments must be connected to the “Y” connector.

Figure 3.2.a: Hose Connector

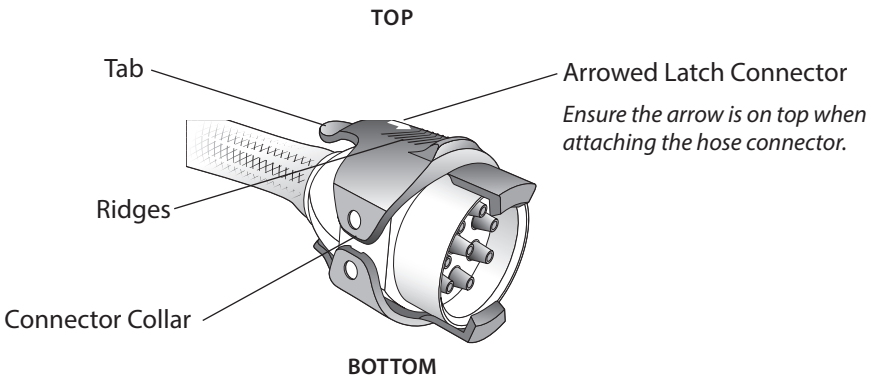

Follow the steps below to attach the hose to the controller unit:

1. Hold the hose connector by the tabs on the back of the latch making sure that the arrow is facing up (Figure 3.2.b).

Figure 3.2.b: Connecting the Hose to the Controller Unit

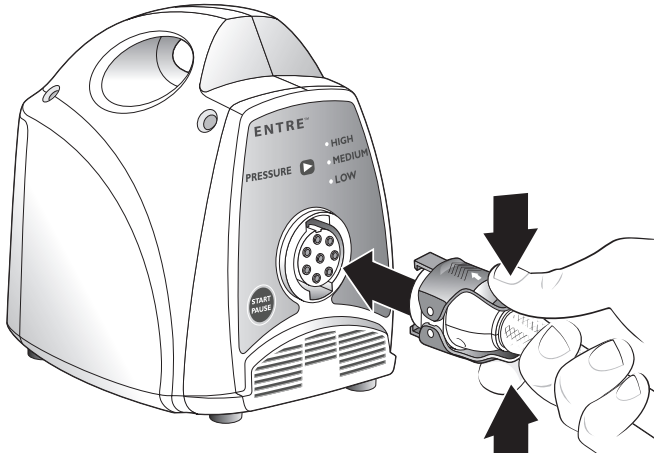

2. Align the arrowed latch with the notch on the controller unit port.
3. Reposition your hand so your thumb and fingers are positioned on the top and bottom latch ridges. This enables you to slide the latch (Figure 3.2.c).

Figure 3.2.c: Proper Handling of the Hose Connector

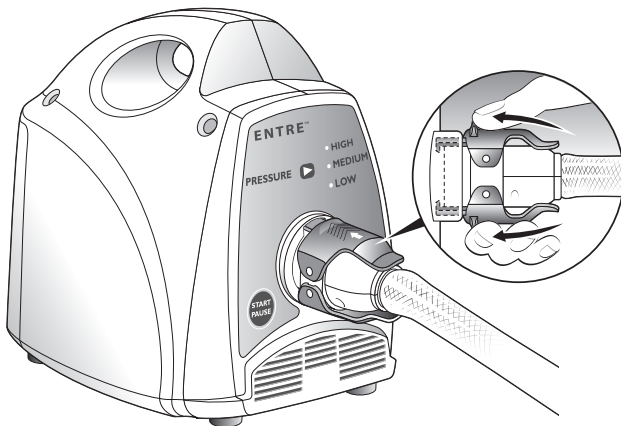

4. Push the latch forward; it will hook on the top and bottom of the controller unit connector. You should hear a click when each of the latches is properly connected. Two clicks will be heard, one for the top and one for the bottom latch (Figure 3.2.d).

Figure 3.2.d: Properly Connecting the Latches

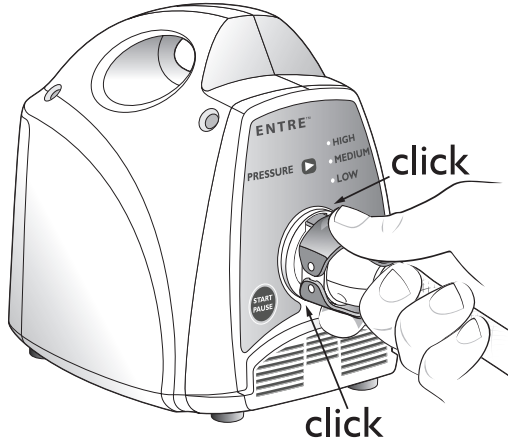

5. If using the “Y” connector, ensure the “Y” connector is attached to the controller unit and both garment connectors are attached to the “Y” connector.

NOTE: *If you are having trouble connecting the latches, try connecting the bottom latch first then tipping the top latch into place.*

Garment Application

Prior to starting therapy it is important to:

1. Be sure you have the recommended garment(s) to complete your therapy.
2. Choose a time that will limit interruptions that would require you to pause therapy. The therapy session lasts one hour.

CAUTION

To avoid skin irritation that may result from contact with the polyester material, wear lightweight, loose-fitting (non-elastic) cotton clothing (example: scrubs, stockinette). If skin irritation develops, consult with your doctor.



Lymph fluid is moved through the vessels in the skin. It is important to avoid wearing anything during therapy that may hamper the lymph flow. These items include:

- **Belts**
- **Jewelry**
- **Restrictive clothing such as:** Elastic-banded underwear, Compression bandaging, Elastic-banded socks, Compression garments, Bra

CAUTION



The Entre garments should not be placed in direct contact with an open wound. It is recommended that wounds be properly dressed before the garment is applied. Contact your healthcare provider if you have any questions.

4.1 Applying the Full Leg and Half Leg Garment

Garment Preparation:

1. Once the garment is connected to the controller unit, unfold and place the full leg or half leg garment(s) on the bed or sofa with the inside garment material (darker fabric) facing up.
2. Configure your garment(s) using the zipper configuration indicated on your Prescribed Treatment Card. Zip the appropriate pull string color (teal or black) to the numbered zipper (#1 or #2). Use the colored zipper to start the zipper. The following zipper configurations are available:
 - Black pull string to zipper #1 – Petite
 - Black pull string to zipper #2 – Small
 - Teal pull string to zipper #1 – Medium
 - Teal pull string to zipper #2 – Large

NOTE: *If you are using an extender, position it so the narrow side is located at the foot of the leg garment. Connect the teal pull string located on the leg garment to the zipper on the extender. Then, connect the teal pull string located on the extender to the #2 zipper on the leg garment.*

3. Zip the garment up half way.

Garment Application:

4. Sit down and slide your leg into the garment (see Figure 4.1.a). Pull the garment up to the top of your thigh (full leg garment) or knee (half leg garment). Zip the garment up completely.

NOTE: *If the suggested configuration is too tight or too loose, try another configuration based on the listings above.*

Figure 4.1.a: Applying the Full Leg or Half Leg Garment

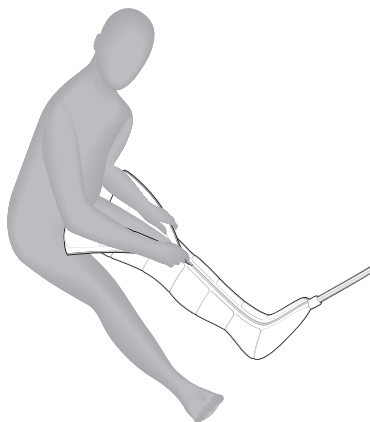

5. Finally, place a pillow under your calf and foot to elevate your leg slightly above your hips for optimal treatment (Figure 4.1.b).

Figure 4.1.b: Fully Applied Full Leg or Half Leg Garment

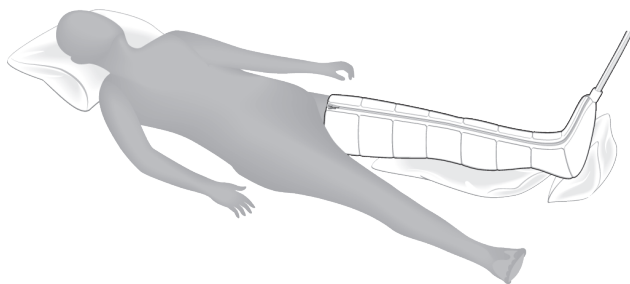

4.2 Applying the Arm Garment

Garment Preparation:

1. Once the garment is connected to the controller unit, unfold and place the arm garment(s) on the bed or sofa with the zipper facing up.

2. Configure your garment(s) using the zipper configuration indicated on your Prescribed Treatment Card. Zip the appropriate pull string color (teal or black) to the numbered zipper (#1 or #2). Use the colored zipper to start the zipper. The following zipper configurations are available:
 - Black pull string to zipper #1 – Petite
 - Black pull string to zipper #2 – Small
 - Teal pull string to zipper #1 – Medium
 - Teal pull string to zipper #2 – Large
3. Zip the garment up completely.

Garment Application:

4. Slide your arm into the garment.

NOTE: *If the suggested configuration is too tight or too loose, try another configuration based on the listings above.*

5. Pull the arm garment up over your shoulder making sure your fingertips remain fully enclosed in the garment. The zipper should align with the top of your shoulder.

**Figure 4.2.a:
Preparing the
Arm Garment**

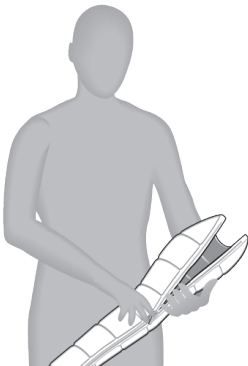

**Figure 4.2.b:
Slide the Arm
Garment On**

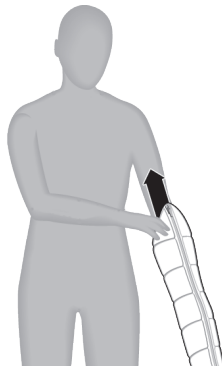

**Figure 4.2.c:
Fully Applied
Arm Garment**

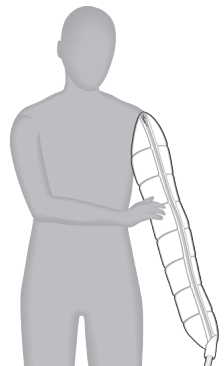

Conducting a Therapy Session

Once you have connected your garment to the controller unit and applied the garment to your limb, you are ready for your therapy session with the Entre system. Start your therapy session using the instructions below.

5.1 Select Your Pressure Setting

Follow the steps outlined below to select the settings prescribed by your healthcare provider:

NOTE: *The controller unit will recall the pressure setting used during the last therapy session. In most situations the pressure settings will not need to be modified from one treatment to the next.*

1. Turn the controller unit ON.

Turn on the controller unit by pressing the ON/OFF button located on the front panel (Figure 5.1.a). The ON/OFF button and PRESSURE setting will illuminate with a green light.

2. Select the pressure setting prescribed by your physician.

The PRESSURE button allows you to toggle between the 3 pressure levels: low, medium and high. Select the prescribed pressure setting listed on your Prescribed Treatment Card.

3. START the controller unit.

Start the controller unit by pressing the START/PAUSE button located on the front panel (Figure 5.1.a). The START/PAUSE button will illuminate with a green light, and the controller unit compressor will start to fill the garment.

Figure 5.1.a: Front Panel

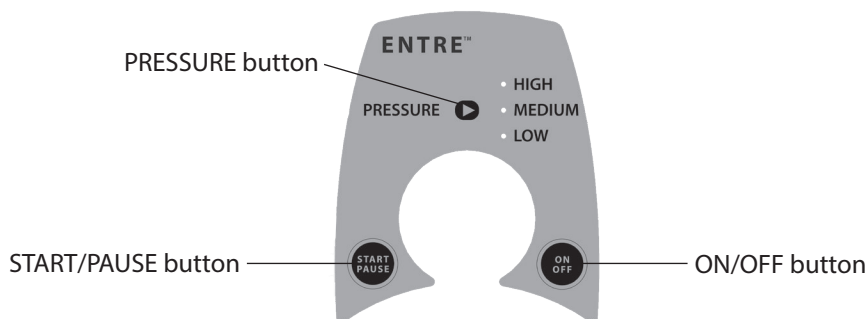

5.2 Starting the Therapy Session

1. Prepare yourself for an uninterrupted therapy session.
2. Lay down on your back with your hips and legs positioned straight. Do not sit in a chair or bend your affected limb(s) during the therapy session.
3. Elevate the affected limb(s) on a pillow just above your hips.
4. Check your pressure setting to ensure you have selected the correct pressure.
5. When properly positioned, press the START/PAUSE button on the controller unit to begin the therapy session.
6. For best results, relax and take deep abdominal breaths during the therapy session.

5.3 Pausing the Therapy Session

You may pause treatment for up to 15 minutes at any point during a therapy session by pressing the START/PAUSE button. To resume your therapy session, press the START/PAUSE button.

NOTE: *The controller unit will remain paused for up to fifteen minutes. After that time, the controller unit will automatically turn off, requiring you to restart your therapy session.*

5.4 Completing the Therapy Session

The therapy program will automatically stop and turn OFF after 1 hour when the treatment has been completed.

NOTE: *Do not unplug the device. This will cause the internal valves to close and the garment(s) will not deflate properly.*

CAUTION



If an electrical power outage or power interruption occurs during a therapy session, the garment(s) may remain inflated.

To remove the garment from your extremity, it may be necessary to disconnect hose connector from the controller unit to allow release of the trapped air.

5.5 Storing the Entre System

To store the Entre system, follow the steps outlined below:

1. Unplug the power adapter cord from the controller unit and from the electrical outlet.
2. Store the garments (and “Y” connector, if supplied) by first coiling the tubing for each of the supplied garments. Avoid kinking the tubing. Garments can be folded. Do not stack anything on top of them.

3. Store the controller unit, garments (and “Y” connector, if supplied) in a cool, dry place. Keep them out of excessive heat or cold. (See Chapter 8 for allowable storage temperatures.) Store them away from children and pets.

5.6 Cleaning the Entire System

To clean the controller unit and/or garments (and “Y” connector, if supplied), follow the steps outlined below.

CAUTION: Read all instructions before cleaning



- Do not submerge
- Do not machine wash
- Do not disassemble
- Do not dry clean
- Do not machine dry
- Do not autoclave
- Do not iron
- Do not steam sterilize

WARNING: Risk of Electric Shock

Unplug the power adapter cord from the electrical outlet prior to cleaning the controller unit. Allow the controller unit to dry completely prior to connecting the power adapter to the electrical outlet.

Cleaning the Controller Unit and “Y” Connector

The controller unit and “Y” connector are to be cleaned, as needed, using a damp cloth and mild household cleaner.

1. Unplug the power adapter from the electrical outlet.
2. Wipe all accessible surfaces, including the power adapter.
3. After cleaning, allow the unit to dry completely prior to using.

Cleaning the Garment(s)

1. A lint brush or roller may be used to remove particles on the inside of the garment(s).
2. The outside portion of the garment(s) may be cleaned using a damp cloth and a mild detergent.
3. Allow garment(s) and accessories to dry thoroughly prior to using.

5.7 Disinfecting the Entre System



CAUTION

Follow instructions and warnings as issued by manufacturer of any disinfecting product.

DisCide® ULTRA Spray Disinfectant has been demonstrated to effectively disinfect the Entre system. Use DisCide ULTRA Spray or similar disinfectant compliant with OSHA's Bloodborne Pathogen Standard (29 CFR 1910.1030) and/or registered with EPA. To disinfect the PD08-U system, including garments, controller or accessories between patient use, or if there are visible biological contaminants or visible stains, the following steps are recommended:

1. Clean any visible blood or body fluids from the surface of the garment.
2. Thoroughly wet surface with DisCide ULTRA Disinfecting Spray.
3. Allow surfaces to remain wet for one minute and then allow to air dry.

Troubleshooting and Specifications

If you experience a problem with the Entre system, refer to the information in Table 1 for assistance. If the information in Table 1 does not help solve the problem, call Customer Service at 612.355.5100 or 833.382.2845 (833.3TACTILE) (toll free, U.S. only).

Table 1: Troubleshooting	
Problem	Recommended Solution
Controller unit does not function, and no LED lights are blinking.	<ol style="list-style-type: none"> 1. Disconnect the power adapter from the back of the controller unit and then reconnect. Ensure that the power adapter is fully inserted in both the power inlet on the back of the controller unit and the wall outlet. Ensure the wall outlet is functioning. A green light will illuminate on the power adapter if the wall outlet and power adapter are functioning. 2. Press the ON/OFF button.
Controller unit does not function, and all LED lights are blinking.	<p>The controller unit detected the system's pressure is too high (most likely due to kinked tubing).</p> <ul style="list-style-type: none"> • Power down the device and wait 5 minutes. If able, disconnect the garment from the controller unit and then reconnect again. Power up the device by pressing the ON/OFF button. Restart the therapy session by pressing the START/PAUSE button. • Ensure the garment tubing is not kinked in any way, as this is the most common reason for the problem. • Do not stand on garment during treatment. • To confirm proper functioning of the controller unit and garment, you may take the garment off and lay it flat on the floor, power up the device and press the START/PAUSE button to begin a therapy session and confirm all chambers sequentially inflate. • Please call Customer Service[®] for assistance if you are unable to resolve the problem.

Problem	Recommended Solution
<p>Controller unit does not function, and the LOW pressure LED light is blinking.</p>	<p>The controller unit was unable to produce or maintain pressure in any of the garment chambers.</p> <ol style="list-style-type: none"> 1. Power down the device. If able, disconnect the garment from the controller unit and then reconnect again. Power up the device by pressing the ON/OFF button. Restart the therapy session by pressing the START/PAUSE button. 2. Please call Customer Service* if you are unable to resolve the problem.
<p>Controller unit does not function, and the MEDIUM pressure LED light is blinking.</p>	<p>The controller unit was unable to release pressure from the system.</p> <ol style="list-style-type: none"> 1. Power down the device. If able, disconnect the garment from the controller unit and then reconnect again. Power up the device by pressing the ON/OFF button. Restart the therapy session by pressing the START/PAUSE button. 2. Please call Customer Service* if unable to resolve the problem.
<p>Controller unit does not function, and the HIGH pressure LED light is blinking.</p>	<p>The controller unit was unable to fill a specific garment chamber.</p> <ol style="list-style-type: none"> 1. Power down the device. Power up the device by pressing the ON/OFF button. Restart the therapy session by pressing the START/PAUSE button. 2. Please call Customer Service* if unable to resolve the problem.
<p>Controller unit does not function, and the HIGH and MEDIUM pressure LED lights are blinking.</p>	<p>The controller unit detected an issue during self-test.</p> <ol style="list-style-type: none"> 1. Power down the device. Power up the device by pressing the ON/OFF button. Restart the therapy session by pressing the START/PAUSE button. 2. Please call Customer Service* if unable to resolve the problem.

Problem	Recommended Solution
<p>Cannot change pressure setting.</p>	<p>Once you start a treatment, settings cannot be changed unless:</p> <ul style="list-style-type: none"> • The treatment program has completed. • The treatment is paused. • The ON/OFF button is pressed. <p>To change pressure setting while a therapy session is in progress, first press the START/PAUSE button. Then settings may be adjusted by pressing the PRESSURE button.</p>
<p>The garment chambers do not fill with air.</p>	<ol style="list-style-type: none"> 1. Verify the ON/OFF and START/PAUSE buttons have been pressed. (A green light will illuminate when the START/PAUSE button is pressed.) 2. Verify that the connectors are attached properly. 3. Use the "Y" connector only when you are using both garments. 4. Ensure that both upper and lower connector latches are engaged. 5. If the chambers still do not fill, turn the machine off, detach the connectors, and turn the machine ON again. 6. Feel for air coming out of the controller unit, reconnect the hose. 7. Press the START/PAUSE button to begin a treatment session.
<p>Garment pressures are higher or lower than expected.</p>	<ol style="list-style-type: none"> 1. Verify that the correct pressure has been selected. 2. Adjust the fit of the garment, ensuring no folds or kinks are in the fabric. 3. Check to be sure the latches are firmly in place and attached properly.
<p>Garment remains inflated.</p>	<p>It is normal for a small amount of air to remain in the chambers between inflations, giving the garment a puffy appearance. If the chambers remain fully inflated:</p> <ol style="list-style-type: none"> 1. Press the ON/OFF button twice in quick succession (ON, OFF, ON, OFF) to allow for another deflation cycle. 2. Ensure that the tubing is not kinked or pinched. 3. Disconnect the connectors and the chambers should deflate.

Problem	Recommended Solution
Controller unit runs longer than expected.	A therapy session will last approximately 60 minutes. Please call Customer Service* (toll free) if controller unit runs significantly longer than 60 minutes.
Zippers have broken or become disconnected from garment.	Please call Customer Service* (toll free) for assistance.
Any button does not function.	<ol style="list-style-type: none"> 1. Power down the device. Power up the device by pressing the ON/OFF button. 2. Please call Customer Service* (toll free) for instructions.
The controller unit makes an abnormal noise.	<ol style="list-style-type: none"> 1. Stop the treatment session by pressing the START/PAUSE button. 2. Verify the noise has stopped. 3. Restart the treatment by pressing the START/PAUSE button. 4. If the noise continues, contact Customer Service*.

***Tactile Medical Customer Service can be contacted at 612.355.5100 or 833.382.2845 (833.3TACTILE) (toll free, U.S. only) 7 a.m. to 7 p.m. Central Time, Monday–Friday.**

Warranty

7.1 Limited Warranty and Service for Home Use

Tactile Medical provides a warranty for the Entre system. The Entre Controller unit, accessories and garments are warranted to be free from defects in material and workmanship for a period of one (1) year from the date of purchase. Tactile Medical's sole obligation in the event of a breach of this warranty is expressly limited to the replacement of defective parts. Replacement parts may be new or reconditioned parts as solely determined by Tactile Medical. No representation or other affirmation of fact set forth in this agreement, including but not limited to statements regarding suitability for use or performance of the Entre system, shall be deemed to be a warranty or representation by Tactile Medical for any purpose, nor give rise to any liability or obligation of Tactile Medical. EXCEPT FOR THE FOREGOING, TACTILE MEDICAL MAKES NO OTHER WARRANTY. THE WARRANTIES SET FORTH HERE ARE IN LIEU OF ALL OTHER WARRANTIES, EXPRESSED OR IMPLIED, WHICH ARE HEREBY DISCLAIMED AND EXCLUDED BY THE MANUFACTURER, INCLUDING WITHOUT LIMITATION ANY WARRANTY OF MERCHANTABILITY OR FITNESS FOR A PARTICULAR PURPOSE OR USE AND ALL OBLIGATIONS OR LIABILITIES ON THE PART OF TACTILE MEDICAL FOR DAMAGES ARISING OUT OF OR IN CONNECTION WITH THE USE, REPLACEMENT OR PERFORMANCE OF THE ENTRE SYSTEM. IN NO EVENT SHALL TACTILE MEDICAL BE LIABLE FOR ANY SPECIAL, DIRECT, INDIRECT OR CONSEQUENTIAL DAMAGES. Some states, provinces or countries do not allow exclusion or limitation of incidental or consequential damages, so the above limitation or exclusion may not apply. This warranty is available only to the

original user and is not transferable. Alterations to the product not conducted by Tactile Medical shall void these warranties. These warranties do not cover failures due to improper or negligent use of the product.

These warranties provide specific legal rights; there may be other available rights, which may vary by state, province or country.

7.2 Limited Warranty and Service for Facility Use

Contact Tactile Medical for information regarding the service agreements available to facilities.

7.3 Return Policy

Returns are not accepted nor are refunds issued for this product, including garments, controller unit or any accessories, once opened.

7.4 Equipment Lifetime

When used and maintained as instructed, the average expected controller unit lifetime is five (5) years.

Tactile Medical reserves the right to modify product specifications as part of its continuing program of product development and quality improvement.

Technical Information

8.1 Technical Information

The Entre system has the following characteristics:

Table 4: Entre System – Technical Information

Model Number	PD08-U
Power Adapter Input	100~240 VAC
Voltage/Frequency	47~63 Hz
Power Adapter Input Current	0.9-0.45 A
Device Input Voltage	12 VDC Nominal
Device Input Current	3.0 A Maximum
Pressure Settings	HIGH, MED and LOW
Controller Unit Size	11.0" x 6.0" x 8.0" (279 mm x 152 mm x 203 mm)
Controller Unit Weight	4 lbs. (1.8 kgs)
Fabrics	Nylon and polyester. Not made with natural rubber latex.
Therapy Programs	1
Chambers	8
Mode of Operation	Continuous
Calibration	Recalibration not required
Electromagnetic Interference (EMI) Electromagnetic Compatibility (EMC)	The Entre system was designed to minimize the effects of external EMI upon the device and to minimize the effect upon the environment from the device. The device conforms to the EMC standards. See Tables 6, 7 and 8.
Operating Atmospheric Pressure	700 to 1060 hPa

Device Transport and Storage Temperature Limits

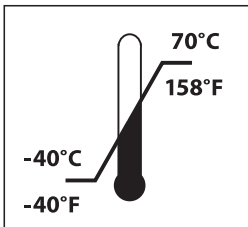

Device Operating Temperature Limits

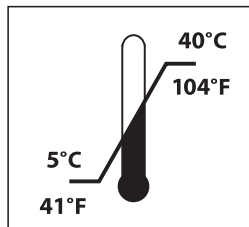

Device Operating Humidity Limits

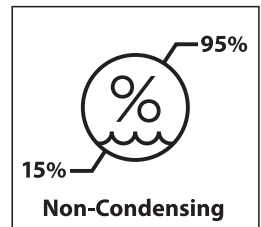

Table 5: Entre System – Classification Information

US FDA Medical Device	Class II per 21 CFR 870.5800 & 21 CFR 890.5650
Canada Medical Device	Class II per Canadian Medical Device Regulation SOR/98-282
European Union Medical Device	Class IIa per Medical Devices Directive 93/42/EEC
Protection Against Electric Shock Hazard	Class I per UL/EN/IEC 60601-1
Protection Against Fluid Ingress	IP21
Applied Part	BF

Table 6: Entre System – Conformance Information

Quality Assurance	FDA 21 CFR 820 QSR ISO 13485
Safety	IEC 60601-1 CAN/CSA C22.2 No. 601.1
Electromagnetic Compatibility (EMC)	IEC 60601-1-2
Waste Electrical & Electronic Equipment (WEEE)	Directive 2002/96/EC
Restriction of Hazardous Substances	Directive 2002/95/EC

Table 7: Guidance and Manufacturer’s Declaration – Electromagnetic Emissions

The Entre system is intended for use in the electromagnetic environment specified below. The customer or the user of the Entre system should assure that it is used in such an environment.

Emissions Test	Compliance	Electromagnetic Environment – Guidance
RF emissions CISPR 11	Group 1	The Entre system uses RF energy only for its internal function. Therefore, its RF emissions are very low and are not likely to cause interference to nearby electronic equipment.
RF emissions CISPR 11	Class B	The Entre system is suitable for use in all establishments, including domestic establishments and those connected to the public low-voltage power adapter network that supplies buildings used for domestic purposes.
Harmonic emissions IEC 61000-3-2	Not Applicable	
Voltage fluctuations/ flicker emissions IEC 61000-3-3	Complies	

**Table 8: Guidance and Manufacturer's Declaration –
Electromagnetic Immunity**

The Entre system is intended for use in the electromagnetic environment specified below. The customer or the user of the Entre should assure that it is used in such an environment.

Immunity Test	IEC 60601 Test Level	Compliance Level	Electromagnetic Environment – Guidance
Electrostatic discharge (ESD) IEC 61000-4-2	± 6 kV contact ± 8 kV air	± 6 kV contact ± 8 kV air	Floors should be wood, concrete or ceramic tile. If floors are covered in synthetic material, the relative humidity should be at least 30%.
Electrical fast transient/burst IEC 61000-4-4	± 2 kV for power supply lines ± 1 kV for input/output lines	± 2 kV for power supply lines ± 1 kV for input/output lines	Mains power quality should be that of a typical commercial or hospital environment.
Surge IEC 61000-4-5	± 1 kV line to line ± 2 kV line to earth	± 1 kV line to line ± 2 kV line to earth	
Voltage dips, short interruptions and voltage variations on power adapter lines IEC 61000-4-11	<5 % U_T (>95 % dip in U_T) for 0.5 cycle 40 % U_T (60 % dip in U_T) for 5 cycles 70 % U_T (30 % dip in U_T) for 25 cycles <5 % U_T (>95 % dip in U_T) for 5 sec	<5 % U_T (>95 % dip in U_T) for 0.5 cycle 40 % U_T (60 % dip in U_T) for 5 cycles 70 % U_T (30 % dip in U_T) for 25 cycles <5 % U_T (>95 % dip in U_T) for 5 sec	Mains power quality should be that of a typical commercial or hospital environment. If the user of the Entre system requires continued operation during power mains interruptions, it is recommended that the device be powered from an uninterruptible power adapter.
Power frequency (50/60 Hz) Magnetic field IEC 61000-4-8	3 A/m	3 A/m	Power frequency magnetic fields should be at levels characteristic of a typical location in a typical commercial or hospital environment.

NOTE U_T is the a.c. mains voltage prior to application of the test level.

**Table 8: Guidance and Manufacturer's Declaration –
Electromagnetic Immunity (continued)**

The Entre system is intended for use in the electromagnetic environment specified below. The customer or the user of the Entre should assure that it is used in such an environment.

Immunity Test	IEC 60601 Test Level	Compliance Level	Electromagnetic Environment – Guidance
Conducted RF IEC 61000-4-6	3 Vrms 150 kHz to 80 MHz	[V1] 3 Vrms	<p>Portable and mobile RF communications equipment should be used no closer to any part of the PD08-U system, including cables, than the recommended separation distance calculated from the equation applicable to the frequency of the transmitter.</p> <p>Recommended separation distance:</p>
Radiated RF IEC 61000-4-3	3 V/m 80 MHz to 2,5 GHz	[E1] 3 V/m	<p>$d = [3,5/V1] \sqrt{P}$ $d = [3,5/E1] \sqrt{P}$ 80 MHz to 800 MHz $d = [7/E1] \sqrt{P}$ 800 MHz to 2.5 GHz</p> <p>Where P is the maximum output power rating of the transmitter in watts (W) according to the transmitter manufacturer and d is the recommended separation distance in meters (m).</p> <p>Field strengths from fixed RF transmitters, as determined by an electromagnetic site survey* should be less than the compliance level in each frequency range†.</p> <p>Interference may occur in the vicinity of equipment marked with the following symbol:</p> 

NOTE 1: At 80 MHz and 800 MHz, the higher frequency range applies.

NOTE 2: These guidelines may not apply in all situations. Electromagnetic propagation is affected by absorption and reflection from structures, objects and people.

* Field strengths from fixed transmitters, such as base stations for radio (cellular/cordless) telephones and land mobile radios, amateur radio, AM and FM radio broadcast and TV broadcast cannot be predicted theoretically with accuracy. To assess the electromagnetic environment due to fixed RF transmitters, an electromagnetic site survey should be considered. If the measured field strength in the location in which the Entre system is used exceeds the applicable RF compliance level above, the PD08-U system should be observed to verify normal operation. If abnormal performance is observed additional measures may be necessary, such as re-orienting or relocating the Entre system.

† Over the frequency range 150 kHz to 80 MHz, field strengths should be less than [V1] V/m.

8.2 Device Labels

The device labels are found on the back and bottom of your device. To read the labels, place the device facing away from you at eye level at a distance that maximizes character clarity — generally 20 inches (50 cm) to 40 inches (100 cm) with an illumination of 500 lx minimum.

Call Tactile Medical Customer Service if label reading issues remain.

NOTE:

- *Device labels are not to scale.*
- *Device labels depiction may be different than that on your device.*
- *See page 2 for symbol definitions.*



This page has intentionally been left blank.

This page has intentionally been left blank.

For Additional Questions

If you have any questions that are not covered by this user guide, contact:

- **By mail:** Tactile Medical, 3701 Wayzata Blvd, Suite 300
Minneapolis, MN 55416
- **By phone:** 612.355.5100
Toll Free Telephone: 833.382.2845 (833.3TACTILE) (U.S. only)
Hours of Operation: 7 a.m. to 7 p.m. Central Time, Monday–Friday
- **By fax:** 612.355.5101
Toll Free Fax: 866.435.3949 (U.S. only)
- **By email:** info@tactilemedical.com
- **Online:** tactilemedical.com

Tactile Medical

3701 Wayzata Blvd, Suite 300
Minneapolis, MN 55416 USA
T: 612.355.5100
F: 612.355.5101

Customer Service

Toll Free Tel: 833.382.2845 (833.3TACTILE)
Toll Free Fax: 866.435.3949
Hours: 7 a.m. to 7 p.m. CT, Monday–Friday
tactilemedical.com

Tactile
MEDICAL[®]
HEALING RIGHT AT HOME

Entre and Healing Right at Home are trademarks of Tactile Medical. DisCide[®] is a registered trademark of Palmero Health Care Corporation. No part of the contents of this guide may be reproduced or transmitted in any way, form, or by any means without the written permission of Tactile Medical.