

# Entre® Plus User Guide

Model PD08-NG

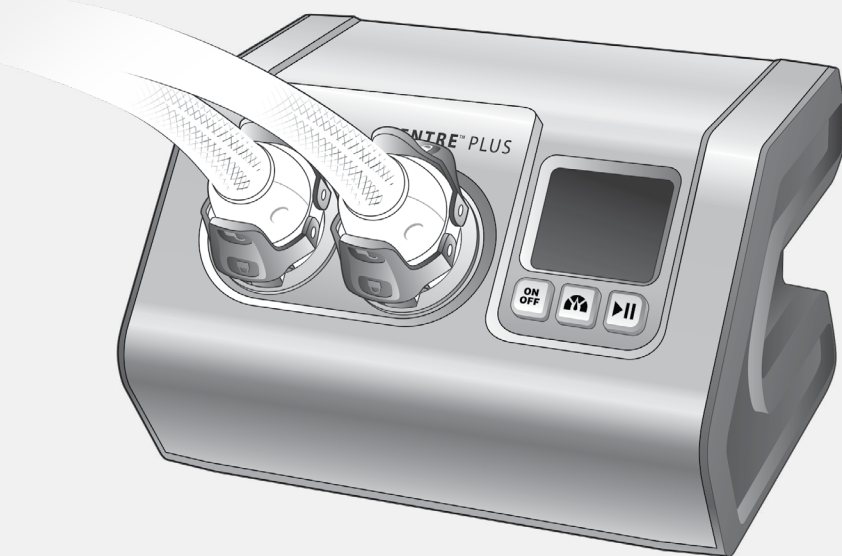

**ENTRE® PLUS**  
PNEUMATIC COMPRESSION SYSTEM

**Tactile**  
MEDICAL®

# Table of Contents

<b>Chapter 1 Before You Get Started</b> .....	<b>1</b>
1.1 How to Contact Tactile Medical .....	1
1.2 Safety Precautions and Explanation of Symbols .....	2
1.3 Indications for Use .....	4
1.4 Contraindications .....	5
1.5 Unpacking Instructions.....	5
1.6 Labels .....	6
<b>Chapter 2 The Entre Plus System</b> .....	<b>7</b>
2.1 System Components .....	7
2.2 Adjustable Pressure Levels .....	8
2.3 Treating the Lower Extremity.....	9
2.4 Treating the Upper Extremity.....	10
<b>Chapter 3 Controller Unit Set-Up</b> .....	<b>11</b>
3.1 Setting Up the Controller Unit .....	11
3.2 Connecting the Hose to the Controller Unit .....	12
<b>Chapter 4 Garment Application</b> .....	<b>15</b>
4.1 Applying the Full Leg and Half Leg Garment .....	16
4.2 Applying the Arm Garment.....	17
<b>Chapter 5 Conducting a Treatment Session</b> .....	<b>19</b>
5.1 Selecting Your Pressure Setting.....	19
5.2 Starting the Treatment Session .....	20
5.3 Pausing the Treatment Session .....	21
5.4 Completing the Treatment Session .....	21
5.5 Storing the Entre Plus System.....	21
5.6 Cleaning the Entre Plus System .....	22
5.7 Disinfecting the Entre Plus System .....	23

**Chapter 6 Troubleshooting and Specifications ..... 24**

**Chapter 7 Warranty ..... 28**

7.1 Limited Warranty and Service for Home Use .....28

7.2 Limited Warranty and Service for Facility Use .....29

7.3 Return Policy .....29

7.4 Equipment Lifetime .....29

**Chapter 8 Technical Information ..... 30**

8.1 Technical Information .....30

8.2 Device Labels.....34

**For Additional Questions..... Back Cover**

# Before You Get Started

Read the entire guide before attempting to connect or operate this product. Keep this guide for future reference.

The Entre Plus system is a pneumatic compression device designed for at-home treatment of lymphedema, chronic edema, venous insufficiency and chronic wounds. When used daily, pneumatic compression can help you manage your condition, improve your health, and allow you to enjoy a better quality of life.

This guide provides the information needed to set up and use your Entre Plus system.









## 1.1 How to Contact Tactile Medical

If you have questions about the Entre Plus system or require service, contact Tactile Medical:

- **By phone:** Customer Service: toll free at 833.3TACTILE (833.382.2845), 7 a.m. to 7 p.m. CT, Monday–Friday.
- **By email:** [info@tactilemedical.com](mailto:info@tactilemedical.com).

If you have medical questions, please contact your physician or healthcare provider.

# 1.2 Safety Precautions and Explanation of Symbols

	<p><b>IMPORTANT: Read Instructions Before Using</b> Before attempting to connect or operate this product, please read the entire guide. Keep this guide available for future reference.</p>
	<p><b>CAUTION</b></p>
	<p><b>Manufacturer's Model ID</b></p>
	<p><b>Rx Only</b> <b>CAUTION:</b> U.S. Federal law restricts this device to sale by, or on the order of, a licensed healthcare professional.</p> <p>Consult your physician or other healthcare provider for recommendations regarding your treatment program, treatment cycles, and/or duration of treatment. Use this product only at the settings prescribed by your healthcare provider.</p>
	<p><b>Do NOT Dispose With General Household Waste</b> Tactile Medical complies with the Waste Electric and Electronic Equipment Directive (WEEE) 2002/96/EC. Contact Tactile Medical toll free at 833.3TACTILE (833.382.2845) to get disposal instructions.</p>
	<p><b>Type BF Applied Part</b></p>
	<p><b>Device Serial Number</b></p>
	<p><b>Intertek Mark</b> Product Category: Medical Equipment Product Category CCN: PIDF Class II with respect to electrical shock, fire and mechanical hazards only in accordance with EN60601-1</p>
<p><b>IP21</b></p>	<p>The Entre Plus system complies with IEC60329 regarding the degree of protection against water and particulates.</p>

### **EMC Precautions**

The Entre Plus system is Medical Electrical Equipment that has been tested and demonstrated to be compatible with electromagnetic compatibility (EMC) CISPR 11 Class B limits and is therefore suitable for use in hospital, clinic and home care environments.

**WARNING:** The Entre Plus provides a sequential inflation and deflation of the garment chambers in a defined sequences. An EM disturbance may cause the controller to stop functioning. Use of this equipment adjacent to or stacked with other equipment should be avoided because it could result in improper operation. If such use is necessary, this equipment and the other equipment should be observed to verify that they are operating normally.

**WARNING:** Power cords can be affected by EMC. Use only the power cord provided by Tactile Medical. Unauthorized power adapters could result in increased electromagnetic emissions or decreased electromagnetic immunity of this equipment and result in improper operation.

Portable RF communications equipment (including peripherals such as antenna cables and external antennas) should be used no closer than 30 cm (12 inches) to any part of the Entre Plus system.

### **WARNING: Risk of Electric Shock**

- Do not attempt to service the controller unit. Such attempts could result in injury or damage to the product, and will void any warranty.
- Do not disassemble the controller unit.
- Unplug the controller unit when not in use.
- The Entre Plus system is to be used indoors only.
- Do not use the controller unit near water or while bathing.
- Do not reach for the controller unit if it falls into water. Unplug the controller unit at the electrical outlet immediately.

### **WARNING: Risk of Personal Injury**

- Use the controller unit only for its intended purpose, as directed in this guide.
- Use only the power adapter provided with your Entre Plus system.
- Use only accessories approved by Tactile Medical. Other accessories may damage the system or interfere with system function.
- Setup the controller unit in a manner that provides easy access to the power adapter should it become necessary to unplug quickly.
- Never operate the controller unit if the power adapter or plug is not working properly, if it has been damaged, or if the controller unit has been dropped into water. Return it to Tactile Medical for inspection and/or replacement. Do not modify the power adapter or plug.

**WARNING: Risk of Personal Injury, continued**

- Keep the power adapter away from heated surfaces.
- Never operate the controller unit where the power adapter or tubing harness will present strangulation or tripping hazard.
- Strangulation potential: Power adapter and tubing bundle should never be placed near or around a person's neck.
- Do not use the Entre Plus system in the presence of flammable gasses, including flammable anesthetics.

**CAUTION: Risk of Device Damage**

- Never block the ventilation openings on the sides of the controller unit. Keep the ventilation openings free of debris such as lint and hair.
- Never operate the controller unit on a soft surface, such as a bed, couch or pillow where the ventilation openings may be blocked.
- Never drop or insert any object into any opening of the controller unit.
- Never use sharp objects, such as pins, scissors or clasps on or near the Flexitouch Plus system.
- Never use hot devices such as irons or blow dryers on or near the Flexitouch Plus system.
- Keep the product free from debris to avoid valve closed or valve opened failures.
- Never place the product in a position or location that would allow the tubing harness to become pinched.

## 1.3 Indications For Use

The Entre Plus system is intended for use by medical professionals and patients who are under medical supervision, for the treatment of the following conditions:

- Chronic edema
- Lymphedema
- Venous insufficiency
- Chronic wounds

## 1.4 Contraindications

The Entre Plus system should not be used if you have one or more of the following conditions:

- Heart failure (acute pulmonary edema, decompensated acute heart failure)
- Acute venous disease (acute thrombophlebitis, acute deep venous thrombosis, acute pulmonary embolism)
- Severe peripheral artery disease (critical limb ischemia including ischemic rest pain, arterial wounds or gangrene)
- Active skin or limb infection/inflammatory disease (acute cellulitis, other uncontrolled skin or untreated inflammatory skin disease)
- Active cancer (cancer that is currently under treatment, but not yet in remission)
- Any circumstance where increased lymphatic or venous return is undesirable

## 1.5 Unpacking Instructions

When your Entre Plus system arrives, it is important that you carefully unpack the contents and ensure that you have all the equipment required to begin operation. If the Entre Plus system is exposed to storage temperature extremes, allow the system to stabilize at room temperature for at least 6 hours before use.

Included in the box, you should find the following:

- Controller unit
- Power adapter
- Garment(s) and accessory(ies) to treat your condition
- Quick Start Guide

The garment(s) and accessory(ies) you receive will depend upon your individual treatment requirements. If you are missing any of the items listed for your prescribed treatment, please contact Customer Service toll free at 833.3TACTILE (833.382.2845).



## Lower Extremity Treatment

The garments and device accessory(ies) needed for lower extremity treatment may include the following:

- Full leg garment
- Half leg garment
- Extender (provided only if ordered)
- Port cover for unilateral treatment

## Upper Extremity Treatment

The garments and device accessory needed for upper extremity treatment may include the following:

- Arm garment
- Port cover for unilateral treatment

## 1.6 Labels

The label is located where the tubing attaches to the garment or accessory. It indicates the body area the garment or accessory is to be applied (full leg, half leg and arm) (**Figure 1.6.a.**).

**Figure 1.6.a. Label Examples**



# The Entre Plus System

The Entre Plus system is a pneumatic compression device that delivers intermittent sequential compression treatment to the affected extremities of patients with lymphedema, chronic edema, venous insufficiency, and chronic wounds.

**NOTE:** *No special skills, training or knowledge is required to operate the Entre Plus system.*

## 2.1 System Components

The Entre Plus system consists of two primary components:

### Controller Unit

The controller unit delivers compressed air via a hose connector which is attached to the garment. Depending on the prescription from your physician, an additional garment can be added to allow simultaneous bilateral treatment. The device applies different levels of pressure along the length of your limb. For example, your toes or fingers will receive more pressure; your thigh or upper arm will receive less.

### Garments and Port Cover

The air-chambered garments are made of soft, pliable nylon and polyester fabrics. They are designed to fit around the limb(s) and fasten with zippers.

*The upper extremity garment(s)* are used to treat the arm.

Depending on your clinical needs and size, you may be prescribed a short or long arm garment.

*The lower extremity garment(s)* are used to treat the leg. Depending on your clinical needs and size, you may be prescribed a short or long full leg garment (with corresponding extender), or a half leg garment.

**NOTE:** Both *Entre* and *Entre Plus* labeled garments can be used with your *Entre Plus* controller.

**Port Cover.** If your healthcare provider ordered unilateral treatment you will receive a port cover to be placed on the unused port.

## 2.2 Adjustable Pressure Levels

Your healthcare provider will determine what pressure setting is appropriate for you. The *Entre Plus* controller unit allows for selection of pressure settings (see **Figure 2.2.a.**). To select the pressure setting recommended by your healthcare provider press the pressure button to toggle to the correct pressure setting.

**NOTE:** Please consult with your healthcare provider before changing pressure settings.

**Figure 2.2.a. Front Panel**

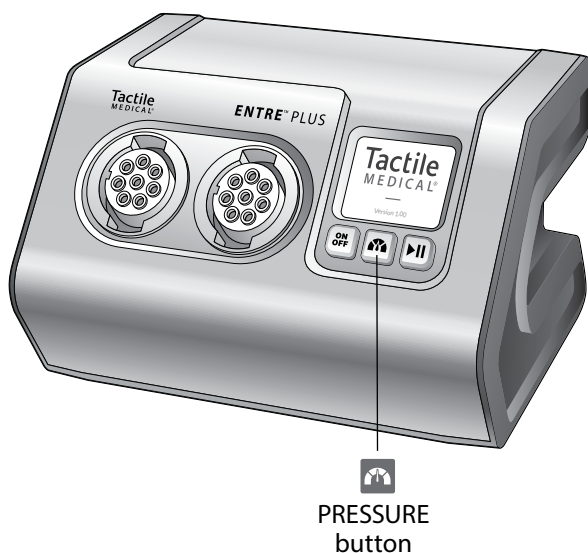

## 2.3 Treating the Lower Extremity

### Full Leg Treatment

This option provides full leg treatment in a distal to proximal (foot to top of thigh) direction via the sequential inflation of the eight chambers.

Treatment time: 60 minutes.

### Half Leg Treatment

This option provides below the knee treatment in a distal to proximal (foot to top of knee) direction via the sequential inflation of the eight chambers.

Treatment time: 60 minutes.

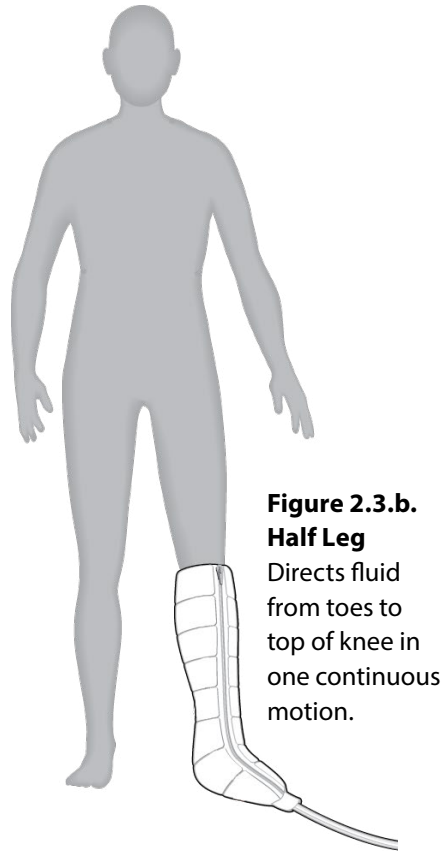
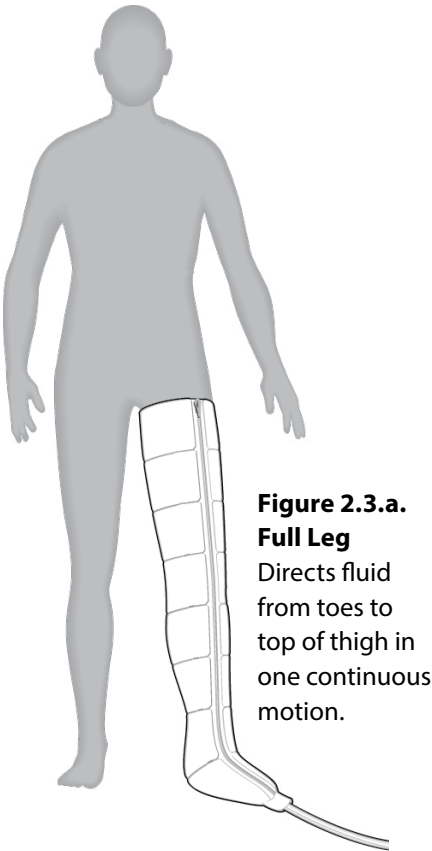

## 2.4 Treating the Upper Extremity

### Full Arm Treatment

This option provides full arm treatment in a distal to proximal (hand to top of biceps) direction via the sequential inflation of the eight chambers.

Treatment time: 60 minutes.

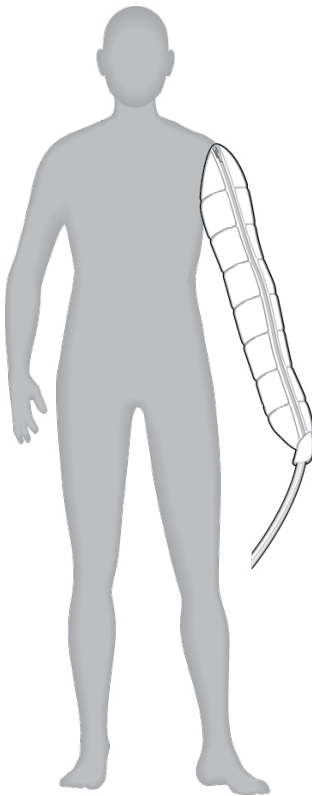

**Figure 2.4.a.**

#### **Arm**

Begins at fingertips and ends at top of biceps in one continuous motion.

# Controller Unit Set-Up

In this chapter you will learn how to set up the controller unit and select the proper settings prior to receiving treatment.

## 3.1 Setting Up the Controller Unit

Follow the steps outlined below:

1. Find an appropriate location for a treatment session (e.g., couch, bed). Place the controller unit on a sturdy, flat surface near an electrical outlet. Position the device so you have easy access to the plug.
2. Plug the supplied power adapter into the power adapter inlet on the back of the controller unit. Then, plug the two-pronged power adapter into an electrical outlet (**Figure 3.1.a.**).

**NOTE:** There are two 12 VDC power adapter options, so the version shown below may be different from the one you receive. The two versions are:

- Meanwell GSM36U12-P1JNX
- Fuhua UE36LCP1-120300SPA

**Figure 3.1.a. Power Adapter**

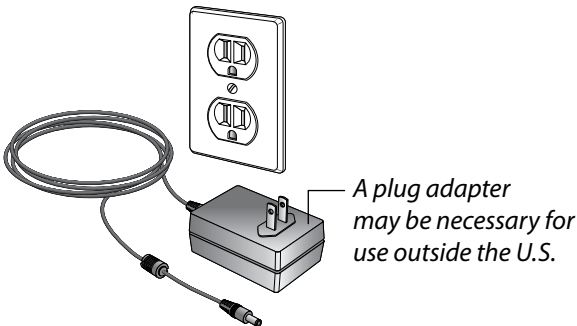

**WARNING: RISK OF ELECTRIC SHOCK**

Only use the Meanwell GSM36U12-P1JNX or Fuhua UE36LCP1-120300SPA power adapter with your Entre Plus system. These power adapters are designed for use with either 120 Volt AC or 230 Volt AC outlets.

### 3.2 Connecting the Hose to the Controller Unit

The controller unit should be connected to the garments before the garments are applied.

**NOTE:** *If prescribed unilateral treatment, place the port cover over the unused port (see **Figure 3.2.e.: Properly Sealing Open Port**).*

**Figure 3.2.a. Hose Connector**

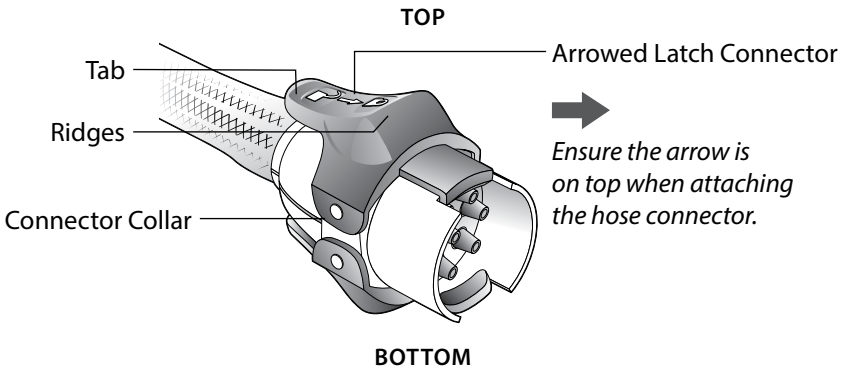

**Follow the steps below to attach the hose to the controller unit:**

1. Hold the hose connector by the tabs on the back of the latch making sure that the arrow is facing up (**Figure 3.2.b.**).

**Figure 3.2.b. Connecting the Hose to the Controller Unit**



2. Align the arrowed latch with the notch on the controller unit port.
3. Reposition your hand so your thumb and fingers are positioned on the top and bottom latch ridges. This enables you to slide the latch (**Figure 3.2.c.**).

**Figure 3.2.c. Proper Handling of the Hose Connector**

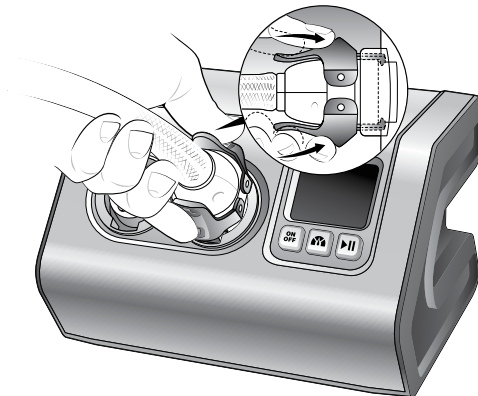



4. Push the latch forward; it will hook on the top and bottom of the controller unit connector. You should hear a click when each of the latches is properly connected. Two clicks will be heard, one for the top and one for the bottom latch (**Figure 3.2.d.**).

**Figure 3.2.d. Properly Connecting the Latches**

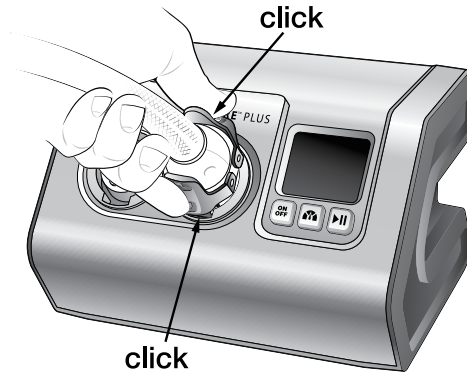

5. If using only one garment, ensure that one of the controller ports is sealed with the port cover (**Figure 3.2.e.**).

**Figure 3.2.e. Properly Sealing Open Port**

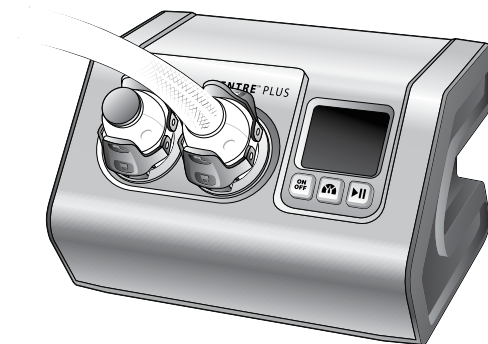

# Garment Application

Prior to starting treatment it is important to:

1. Be sure you have the recommended garment(s) to complete your treatment.
2. Choose a time that will limit interruptions that would require you to pause treatment. The treatment session lasts one hour.

## CAUTION

To avoid skin irritation that may result from contact with the polyester material, wear lightweight, loose-fitting (non-elastic) cotton clothing (example: scrubs, stockinette). If skin irritation develops, consult with your doctor.



Lymph fluid is moved through the vessels in the skin. It is important to avoid wearing anything during treatment that may hamper the lymph flow. These items include:

- **Belts**
- **Jewelry**
- **Restrictive clothing such as:** Elastic-banded underwear, Compression bandaging, Elastic-banded socks, compression garments, Bra

## CAUTION



The Entre Plus garments should not be placed in direct contact with an open wound. It is recommended that wounds be properly dressed before the garment is applied. Contact your healthcare provider if you have any questions.

## 4.1 Applying the Full Leg and Half Leg Garment

### Garment Preparation:

1. Once the garment is connected to the controller unit, unfold and place the full leg or half leg garment(s) on the bed or sofa with the inside garment material (darker fabric) facing up.
2. Configure your garment(s) using the zipper configuration indicated on your Prescribed Treatment Card. Zip the appropriate pull string color (teal or black) to the numbered zipper (#1 or #2). Use the colored zipper to start the zipper. The following zipper configurations are available:
  - Black pull string to zipper #1 – Petite
  - Black pull string to zipper #2 – Small
  - Teal pull string to zipper #1 – Medium
  - Teal pull string to zipper #2 – Large

**NOTE:** *If you are using an extender, position it so the narrow side is located at the foot of the leg garment. Connect the teal pull string located on the leg garment to the zipper on the extender. Then, connect the teal pull string located on the extender to the #2 zipper on the leg garment.*

3. Zip the garment up half way.

### Garment Application:

4. Sit down and slide your leg into the garment (see **Figure 4.1.a.**). Pull the garment up to the top of your thigh (full leg garment) or knee (half leg garment); your foot should not exit the front of the garment. Zip the garment up completely and ensure the zipper pull is flat against the base to lock the zipper in place.

**NOTE:** *If the suggested configuration is too tight or too loose, try another configuration based on the listings above.*

**Figure 4.1.a. Applying the Full Leg or Half Leg Garment**

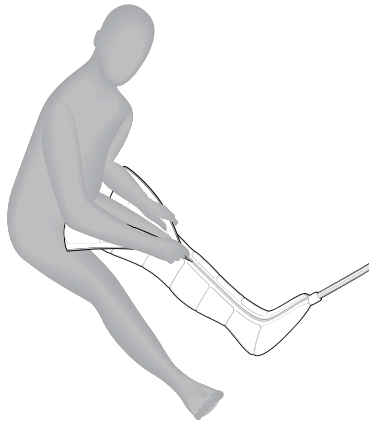

5. Finally, place a pillow under your calf and foot to elevate your leg slightly above your hips for optimal treatment (**Figure 4.1.b.**).

**Figure 4.1.b. Fully Applied Full Leg or Half Leg Garment**

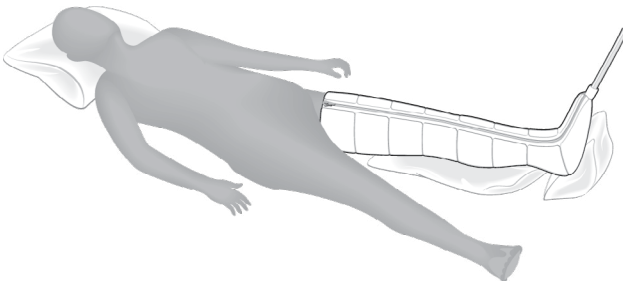

## **4.2 Applying the Arm Garment**

### **Garment Preparation:**

1. Once the garment is connected to the controller unit, unfold and place the arm garment(s) on the bed or sofa with the zipper facing up.

2. Configure your garment(s) using the zipper configuration indicated on your Prescribed Treatment Card. Zip the appropriate pull string color (teal or black) to the numbered zipper (#1 or #2). Use the colored zipper to start the zipper. The following zipper configurations are available:
  - Black pull string to zipper #1 – Petite
  - Black pull string to zipper #2 – Small
  - Teal pull string to zipper #1 – Medium
  - Teal pull string to zipper #2 – Large
3. Zip the garment up completely and ensure the zipper pull is flat against the base to lock the zipper in place.

### **Garment Application:**

4. Slide your arm into the garment.

**NOTE:** *If the suggested configuration is too tight or too loose, try another configuration based on the listings above.*

5. Pull the arm garment up over your shoulder making sure your fingertips remain fully enclosed in the garment. The zipper should align with the top of your shoulder.

**Figure 4.2.a.**  
**Preparing the**  
**Arm Garment**

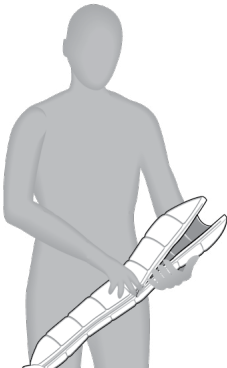

**Figure 4.2.b.**  
**Slide the**  
**Arm Garment On**

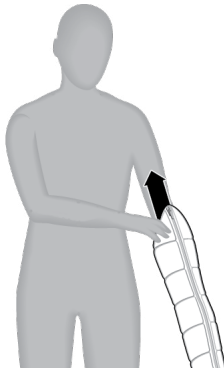

**Figure 4.2.c.**  
**Fully Applied**  
**Arm Garment**

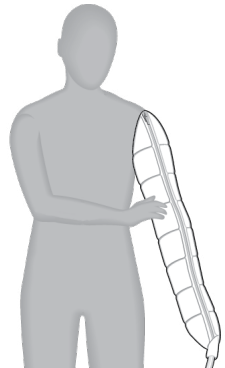

# Conducting a Treatment Session

Once you have connected your garment to the controller unit and applied the garment to your limb, you are ready for your treatment session with the Entre Plus system. Start your treatment session using the instructions below.

## 5.1 Selecting Your Pressure Setting

Follow the steps outlined below to select the settings prescribed by your healthcare provider:

**NOTE:** *The controller unit will recall the pressure setting used during the last treatment session. In most situations the pressure settings will not need to be modified from one treatment to the next.*

### 1. Turn the controller unit ON.

Turn on the controller unit by pressing the  button located on the front panel (**Figure 5.1.a.**). The LCD screen will illuminate.

### 2. Select the pressure setting prescribed by your physician.

The  button allows you to toggle between the three pressure levels: low, medium and high. Select the prescribed pressure setting listed on your Prescribed Treatment Card.

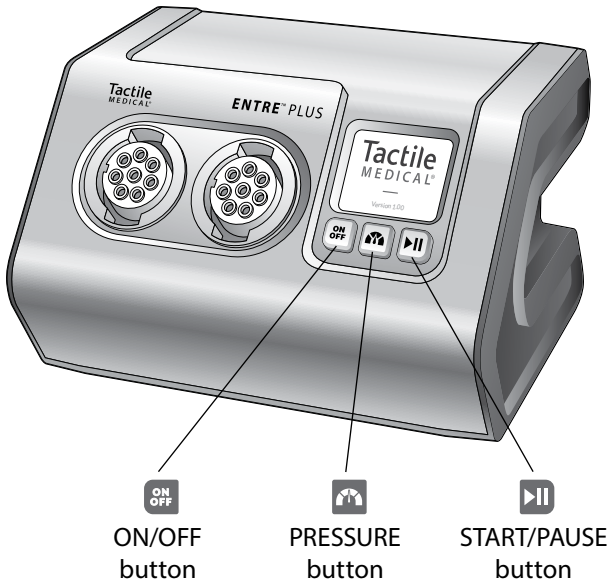

**Figure 5.1.a. Front Panel**



## 5.2 Starting the Treatment Session

1. Prepare yourself for an uninterrupted treatment session.
2. Lay down on your back with your hips and legs positioned straight. Do not sit in a chair or bend your affected limb(s) during the treatment session.
3. Elevate the affected limb(s) on a pillow just above your hips.
4. Check your pressure setting to ensure you have selected the correct pressure.
5. When properly positioned, press the  button on the controller unit to begin the treatment session.
6. For best results, relax and take deep abdominal breaths during the treatment session.

## 5.3 Pausing the Treatment Session

You may pause treatment for up to 15 minutes at any point during a treatment session by pressing the  button. To resume your treatment session, press the  button.

**NOTE:** *The controller unit will remain paused for up to 15 minutes. After that time, the controller unit will automatically turn off, requiring you to restart your treatment session.*

## 5.4 Completing the Treatment Session

The treatment program will automatically stop once the treatment is complete. The LCD screen will display “Successfully Completed”; at this time the garment will begin to deflate.

**NOTE:** *Do not turn off or disconnect the garment during this deflation process.*

### CAUTION



If an electrical power outage or power interruption occurs during a treatment session, the garment(s) may remain inflated.

To remove the garment from your extremity, it may be necessary to disconnect hose connector from the controller unit to allow release of the trapped air.

## 5.5 Storing the Entre Plus System

To store the Entre Plus system, follow the steps outlined below:

1. Unplug the power adapter cord from the controller unit and from the electrical outlet.
2. Store the garments by first coiling the tubing for each of the supplied garments. Avoid kinking the tubing. Garments can be folded. Do not stack anything on top of them.



3. Store the controller unit and garments in a cool, dry place. Keep them out of excessive heat or cold. (See **Chapter 8** for allowable storage temperatures.) Store them away from children and pets.

## 5.6 Cleaning the Entre Plus System

To clean the controller unit and/or garments, follow the steps outlined below.



**CAUTION: Read all instructions before cleaning**

- Do not submerge
- Do not disassemble
- Do not machine dry
- Do not iron
- Do not machine wash
- Do not dry clean
- Do not autoclave
- Do not steam sterilize

**WARNING: Risk of Electric Shock**

Unplug the power adapter cord from the electrical outlet prior to cleaning the controller unit. Allow the controller unit to dry completely prior to connecting the power adapter to the electrical outlet.

### Cleaning the Controller Unit

The controller unit can be cleaned, as needed, using a damp cloth and mild household cleaner:

1. Unplug the power adapter from the electrical outlet.
2. Wipe all accessible surfaces, including the power adapter.
3. After cleaning, allow the unit to dry completely prior to using.

## **Cleaning the Garment(s)**

1. A lint brush or roller may be used to remove particles on the inside of the garment(s).
2. The outside portion of the garment(s) may be cleaned using a damp cloth and a mild detergent.
3. Allow garment(s) and accessories to dry thoroughly prior to using.

## **5.7 Disinfecting the Entre Plus System**



### **CAUTION**





Follow instructions and warnings as issued by manufacturer of any disinfecting product.









DisCide® ULTRA Spray Disinfectant has been demonstrated to effectively disinfect the Entre Plus system. Use DisCide ULTRA Spray or similar disinfectant compliant with OSHA's Bloodborne Pathogen Standard (29 CFR 1910.1030) and/or registered with EPA. To disinfect the Entre Plus system, including garments, controller or accessories between patient use, or if there are visible biological contaminants or visible stains, the following steps are recommended:





1. Clean any visible blood or body fluids from the surface of the garment.
2. Thoroughly wet surface with DisCide ULTRA Disinfecting Spray.
3. Allow surfaces to remain wet for one minute and then allow to air dry.





# Troubleshooting and Specifications

If you experience a problem with the Entre Plus system, refer to the information in Table 1 for assistance. If the information in Table 1 does not help solve the problem, call Customer Service toll free at 833.3TACTILE (833.382.2845).

Table 1: Troubleshooting	
Problem	Recommended Solution
<b>Controller unit does not function or display does not illuminate.</b>	<ol style="list-style-type: none"> <li>1. Disconnect the power adapter from the back of the controller unit and then reconnect. Ensure that the power adapter is fully inserted in both the power inlet on the back of the controller unit and the wall outlet. Ensure the wall outlet is functioning. A green light will illuminate on the power adapter if the wall outlet and power adapter are functioning.</li> <li>2. Press the  button.</li> </ol>
<b>The chambers do not fill with air (controller screen may indicate the treatment completed with result R3, R4, R5, R6, R7 or R8).</b>	<p>The controller unit detected the system's pressure is too high (most likely due to kinked tubing).</p> <ol style="list-style-type: none"> <li>1. Power down the device. If able, disconnect the garment from the controller unit and then reconnect again. Power up the device by pressing the  button. Restart the treatment session by pressing the  button.</li> <li>2. Ensure the garment tubing is not kinked in any way, as this is the most common reason for the problem.</li> <li>3. Do not stand on garment during treatment.</li> <li>4. To confirm proper functioning of the controller unit and garment, you may take the garment off and lay it flat on the floor, power up the device and press the  button to begin a treatment session and confirm all chambers sequentially inflate.</li> <li>5. Please call Customer Service* for assistance if you are unable to resolve the problem.</li> </ol>

Problem	Recommended Solution
<b>Controller unit does not work, and the garments do not inflate</b>	<p>The controller unit was unable to produce or maintain pressure in any of the garment chambers.</p> <ol style="list-style-type: none"> <li>1. Power down the device. If able, disconnect the garment from the controller unit and then reconnect again. Power up the device by pressing the  button. Restart the treatment session by pressing the  button.</li> <li>2. Please call Customer Service* if you are unable to resolve the problem.</li> </ol>
<b>Controller unit does not function, and holds pressure in the garments.</b>	<p>The controller unit was unable to release pressure from the system.</p> <ol style="list-style-type: none"> <li>1. Power down the device. If able, disconnect the garment from the controller unit and then reconnect again. Power up the device by pressing the  button. Restart the treatment session by pressing the  button.</li> <li>2. Please call Customer Service* if you are unable to resolve the problem.</li> </ol>
<b>Controller unit does not function, and an error message appeared on the LCD screen.</b>	<p>The controller unit detected an issue during self-test.</p> <ol style="list-style-type: none"> <li>1. Power down the device. Power up the device by pressing the  button. Restart the treatment session by pressing the  button.</li> <li>2. Please call Customer Service* if you are unable to resolve the problem.</li> </ol>
<b>Cannot change pressure setting.</b>	<p>Once you start a treatment, settings cannot be changed unless:</p> <ul style="list-style-type: none"> <li>▪ The treatment program has completed.</li> <li>▪ The  button is pressed.</li> </ul> <p>To change pressure settings, power off the device. Then power up the device by pressing the  button. Then settings may be adjusted by pressing the  button.</p>

Problem	Recommended Solution
<p><b>The garment chambers do not fill with air.</b></p>	<ol style="list-style-type: none"> <li>1. Verify the  and  buttons have been pressed. (The LCD screen will illuminate when the  button is pressed.)</li> <li>2. Verify that the connectors are attached properly and that the hoses are not kinked.</li> <li>3. Ensure that both upper and lower connector latches are engaged.</li> <li>4. If the chambers still do not fill, turn the machine off, detach the connectors, and turn the machine ON again.</li> <li>5. Press the  button to begin a treatment session.</li> <li>6. Feel for air coming out of the controller unit, reconnect the hose.*</li> </ol> <p>*If using only one garment, ensure the port is attached according to Section 3.2 step 5.</p>
<p><b>Garment pressures are higher or lower than expected.</b></p>	<ol style="list-style-type: none"> <li>1. Verify that the correct pressure has been selected.</li> <li>2. Adjust the fit of the garment, ensuring no folds or kinks are in the fabric.</li> <li>3. Check to be sure the latches are firmly in place and attached properly.</li> </ol>
<p><b>Garment remains inflated.</b></p>	<p>It is normal for a small amount of air to remain in the chambers between inflations, giving the garment a puffy appearance. If the chambers remain fully inflated:</p> <ol style="list-style-type: none"> <li>1. Press and hold the  button for at least three seconds to start the active exhaust process.</li> <li>2. Ensure that the tubing is not kinked or pinched.</li> <li>3. Disconnect the connectors and the chambers should deflate.</li> </ol>
<p><b>Controller unit runs longer than expected.</b></p>	<p>A treatment session will last approximately 60 minutes. Please call Customer Service* (toll free) if controller unit runs significantly longer than 60 minutes.</p>

<b>Zippers have broken or become disconnected from garment.</b>	Please call Customer Service* (toll free) for assistance.
Problem	Recommended Solution
<b>Any button does not function.</b>	<ol style="list-style-type: none"> <li>1. Power down the device. Power up the device by pressing the  button.</li> <li>2. Please call Customer Service* (toll free) for instructions.</li> </ol>
<b>The controller unit makes an abnormal noise.</b>	<ol style="list-style-type: none"> <li>1. Stop the treatment session by pressing the  button.</li> <li>2. Verify the noise has stopped.</li> <li>3. Restart the treatment by pressing the  button.</li> <li>4. If the noise continues, stop the treatment by pressing the  button and contact Customer Service*.</li> </ol>

**\*Tactile Medical Customer Service can be contacted toll free at 833.3TACTILE (833.382.2845), 7 a.m. to 7 p.m. CT, Monday–Friday.**

# Warranty

## 7.1 Limited Warranty and Service for Home Use

Tactile Medical provides a warranty for the Entre Plus system. The Entre Plus Controller unit, garments and garment accessories are warranted to be free from defects in material and workmanship for a period of one (1) year from the date of purchase. Tactile Medical's sole obligation in the event of a breach of this warranty is expressly limited to the replacement of defective parts. Replacement parts may be new or reconditioned parts as solely determined by Tactile Medical. No representation or other affirmation of fact set forth in this agreement, including but not limited to statements regarding suitability for use or performance of the Entre Plus system, shall be deemed to be a warranty or representation by Tactile Medical for any purpose, nor give rise to any liability or obligation of Tactile Medical. EXCEPT FOR THE FOREGOING, TACTILE MEDICAL MAKES NO OTHER WARRANTY. THE WARRANTIES SET FORTH HERE ARE IN LIEU OF ALL OTHER WARRANTIES, EXPRESSED OR IMPLIED, WHICH ARE HEREBY DISCLAIMED AND EXCLUDED BY THE MANUFACTURER, INCLUDING WITHOUT LIMITATION ANY WARRANTY OF MERCHANTABILITY OR FITNESS FOR A PARTICULAR PURPOSE OR USE AND ALL OBLIGATIONS OR LIABILITIES ON THE PART OF TACTILE MEDICAL FOR DAMAGES ARISING OUT OF OR IN CONNECTION WITH THE USE, REPLACEMENT OR PERFORMANCE OF THE ENTRE PLUS SYSTEM. IN NO EVENT SHALL TACTILE MEDICAL BE LIABLE FOR ANY SPECIAL, DIRECT, INDIRECT OR CONSEQUENTIAL DAMAGES. Some states, provinces or countries do not allow exclusion or limitation of incidental or consequential damages, so the above limitation or exclusion may not apply.

This warranty is available only to the original user and is not transferable. Alterations to the product not conducted by Tactile Medical shall void these warranties. These warranties do not cover failures due to improper or negligent use of the product.

These warranties provide specific legal rights; there may be other available rights, which may vary by state, province or country.

## **7.2 Limited Warranty and Service for Facility Use**

Contact Tactile Medical for information regarding the service agreements available to facilities.

## **7.3 Return Policy**

Returns are accepted for unopened product within 60 days of receipt. Products, such as replacement controllers, garments or accessories outside or not covered by the warranty, are available for purchase.

## **7.4 Equipment Lifetime**

When used and maintained as instructed, the average expected controller unit lifetime is five (5) years.

Tactile Medical reserves the right to modify product specifications as part of its continuing program of product development and quality improvement.



# Technical Information

## 8.1 Technical Information

The Entre Plus system has the following characteristics:

<b>Table 4: Entre Plus System – Technical Information</b>	
Model Number	PD08-NG
Power Adapter Input	100~240 VAC
Voltage/Frequency	47~63 Hz
Power Adapter Input Current	0.9-0.45 A
Device Input Voltage	12 VDC Nominal
Device Input Current	3.0 A Maximum
Pressure Settings	HIGH, MED and LOW
Controller Unit Size	9.0" x 8.5" x 5.0" (228 mm x 215.9 mm x 127 mm)
Controller Unit Weight	5.5 lbs. (2.2 kgs)
Fabrics	Nylon and polyester. Not made with natural rubber latex.
Therapy Programs	1
Chambers	8
Mode of Operation	Continuous
Calibration	Recalibration not required
Electromagnetic Interference (EMI) Electromagnetic Compatibility (EMC)	The Entre Plus system was designed to minimize the effects of external EMI upon the device and to minimize the effect upon the environment from the device. The device conforms to the EMC standards. See Tables 6, 7 and 8.
Operating Atmospheric Pressure	700 to 1060 hPa

### Device Transport and Storage Temperature Limits

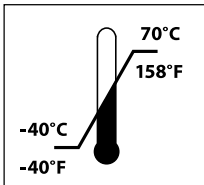

### Device Operating Temperature Limits

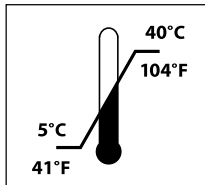

### Device Transport and Storage Humidity Limits

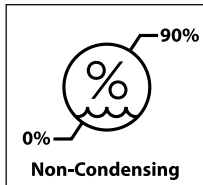

### Device Operating Humidity Limits

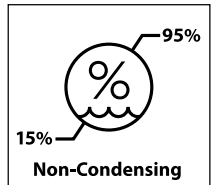

**Table 5: Entre Plus System – Classification Information**

U.S. FDA Medical Device	Class II per 21 CFR 870.5800
Protection Against Electric Shock Hazard	Class I per UL/EN/IEC 60601-1
Protection Against Fluid Ingress	IP21
Applied Part	BF

**Table 6: Entre Plus System – Conformance Information**

Quality Assurance	FDA 21 CFR 820 QSR ISO 13485
Safety	IEC 60601-1 CAN/CSA C22.2 No. 601.1
Electromagnetic Compatibility (EMC)	IEC 60601-1-2
Waste Electrical & Electronic Equipment (WEEE)	Directive 2002/96/EC
Restriction of Hazardous Substances	Directive 2002/95/EC

**Table 7: Guidance and Manufacturer’s Declaration – Electromagnetic Emissions**

The Entre Plus system is intended for use in the electromagnetic environment specified below. The customer or the user of the Entre Plus system should assure that it is used in such an environment.

<b>Emissions Test</b>	<b>Compliance</b>	<b>Electromagnetic Environment – Guidance</b>
RF emissions CISPR 11	Group 1	The Entre Plus system uses RF energy only for its internal function. Therefore, its RF emissions are very low and are not likely to cause interference to nearby electronic equipment.  The Entre Plus system is suitable for use in all establishments, including domestic establishments and those connected to the public low-voltage power adapter network that supplies buildings used for domestic purposes.
RF emissions CISPR 11	Class B	
Harmonic emissions IEC 61000-3-2	Not Applicable	
Voltage fluctuations/ flicker emissions IEC 61000-3-3	Complies	

**Table 8: Guidance and Manufacturer's Declaration –  
Electromagnetic Immunity**

The Entre Plus system is intended for use in the electromagnetic environment specified below. The customer or the user of the Entre Plus should assure that it is used in such an environment.

<b>Immunity Test</b>	<b>IEC 60601 Test Level</b>	<b>Compliance Level</b>	<b>Electromagnetic Environment – Guidance</b>
Electrostatic discharge (ESD) IEC 61000-4-2	± 6 kV contact ± 8 kV air	± 8 kV contact +/-2 kV, +/-4 kV, +/-8 kV, +/-15 kV air	Floors should be wood, concrete or ceramic tile. If floors are covered in synthetic material, the relative humidity should be at least 30%.
Electrical fast transient/burst IEC 61000-4-4	± 2 kV for power supply lines ± 100 kHz repetition	± 2 kV for power supply lines ± 100 kHz repetition	Mains power quality should be that of a typical commercial or hospital environment.
Surge IEC 61000-4-5	± -5 kV ± -1 kV line to line ± -5 kV ± -1 kV ± -2 kV line to earth	± -5 kV ± -1 kV line to line ± -5 kV ± -1 kV ± -2 kV line to earth	
Voltage dips, short interruptions and voltage variations on power adapter lines IEC 61000-4-11	Voltage dips 0% UT; 0,5 cycle At 0°, 45°, 90°, 135°, 180°, 225°, 270° and 315° 0% UT; 1 cycle and 70% UT; 25 periods at 50Hz, 30 periods at 60Hz Single phase: at 0° Voltage Interruptions 0% UT; 250 periods at 50Hz, 300 periods at 60Hz	Voltage dips 0% UT; 0,5 cycle At 0°, 45°, 90°, 135°, 180°, 225°, 270° and 315° 0% UT; 1 cycle and 70% UT; 25 periods at 50Hz, 30 periods at 60Hz Single phase: at 0° Voltage Interruptions 0% UT; 250 periods at 50Hz, 300 periods at 60Hz	Mains power quality should be that of a typical commercial or hospital environment. If the user of the Entre Plus system requires continued operation during power mains interruptions, it is recommended that the device be powered from an uninterruptible power adapter.

**NOTE**  $U_T$  is the a.c. mains voltage prior to application of the test level.

**Table 8: Guidance and Manufacturer's Declaration –  
Electromagnetic Immunity (continued)**

The Entre Plus system is intended for use in the electromagnetic environment specified below. The customer or the user of the Entre Plus should assure that it is used in such an environment.

<b>Immunity Test</b>	<b>IEC 60601 Test Level</b>	<b>Compliance Level</b>	<b>Electromagnetic Environment – Guidance</b>
Power frequency (50/60 Hz) Magnetic field IEC 61000-4-8	3 A/m	3 A/m	Power frequency magnetic fields should be at levels characteristic of a typical location in a typical commercial or hospital environment.
Conducted RF IEC 61000-4-6	3 Vrms 150 kHz to 80 MHz  6 Vrms in ISM and amateur radio bands between 0.15 MHz and 80 MHz 80% AM at 1 kHz	3 Vrms .15 kHz to 80 MHz  6 Vrms in ISM and amateur radio bands between 0.15 MHz and 80 MHz 80% AM at 1 kHz	
Radiated RF IEC 61000-4-3	10 V/m 80 MHz to 2,7 GHz 80 AM at 1kHz	10 V/m 80 MHz to 2,7 GHz 80 AM at 1kHz	

**NOTE 1:** At 80 MHz and 800 MHz, the higher frequency range applies.

**NOTE 2:** These guidelines may not apply in all situations. Electromagnetic propagation is affected by absorption and reflection from structures, objects and people.

\* Field strengths from fixed transmitters, such as base stations for radio (cellular/cordless) telephones and land mobile radios, amateur radio, AM and FM radio broadcast and TV broadcast cannot be predicted theoretically with accuracy. To assess the electromagnetic environment due to fixed RF transmitters, an electromagnetic site survey should be considered. If the measured field strength in the location in which the Entre Plus system is used exceeds the applicable RF compliance level above, the Entre Plus system should be observed to verify normal operation. If abnormal performance is observed additional measures may be necessary, such as re-orienting or relocating the Entre Plus system.

## 8.2 Device Labels

The device labels are found on the back and bottom of your device. To read the labels, place the device facing away from you at eye level at a distance that maximizes character clarity — generally 20 inches (50 cm) to 40 inches (100 cm) with an illumination of 500 lx minimum.

Call Tactile Medical Customer Service if label reading issues remain.

**NOTE:**

- *Device labels are not to scale.*
- *Device labels depiction may be different than that on your device.*
- *See page 2 for symbol definitions.*

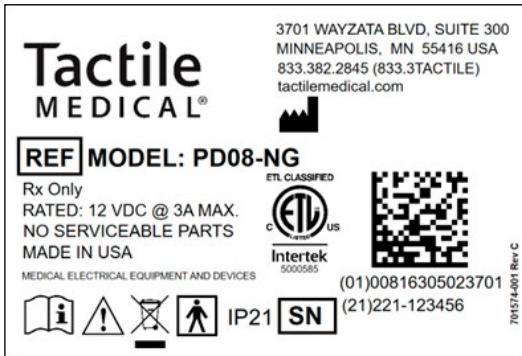

This page has intentionally been left blank.

This page has intentionally been left blank.

## For Additional Questions

If you have any questions that are not covered by this User Guide, contact:

- **By mail:** Tactile Medical, 3701 Wayzata Blvd, Suite 300  
Minneapolis, MN 55416 U.S.
- **By phone:** Toll free: 833.3TACTILE (833.382.2845)  
Hours: 7 a.m. to 7 p.m. CT, Monday–Friday
- **By fax:** Toll free: 866.435.3949
- **By email:** [info@tactilemedical.com](mailto:info@tactilemedical.com)
- **Visit:** [tactilemedical.com](https://tactilemedical.com)

### Tactile Medical

3701 Wayzata Blvd, Suite 300  
Minneapolis, MN 55416 USA  
T: 612.355.5100  
F: 612.355.5101

### Customer Care

Toll Free Tel: 833.3TACTILE (833.382.2845)  
Toll Free Fax: 866.435.3949  
Hours: 7 a.m. to 7 p.m. CT, Monday–Friday  
[tactilemedical.com](https://tactilemedical.com)

**Tactile**  
MEDICAL®  
HEALING RIGHT AT HOME

Tactile Medical and Entre are registered trademarks and Healing Right at Home is a trademark of Tactile Medical. DisCide® is a registered trademark of Palmero Health Care Corporation. No part of the contents of this guide may be reproduced or transmitted in any way, form, or by any means without the written permission of Tactile Medical.